

ZIP-TOGGLE® WITH SCREWS

PRODUCT DESCRIPTION

- Self drilling gypsum wallboard anchor
- Unique patented design
- Comes standard with special screw included



GENERAL APPLICATIONS AND USES



Light duty applications including:

- Brackets
- Mirrors
- Signage
- Light bathroom fittings



BASE MATERIAL: IDEAL FOR PLASTERBOARD



Cat No.	Description	 Length [mm]	 Box Quantity	 Carton Quantity
DFM4570000	Zip-Toggle - Nylon with Screw	50	1x50	8x50

INSTALLATION INSTRUCTIONS

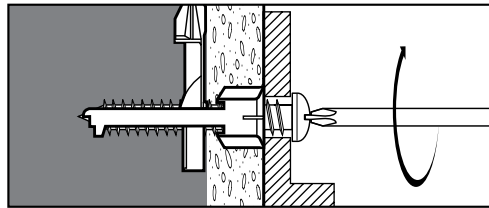
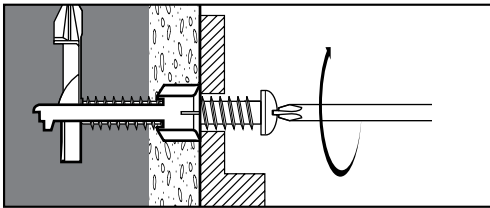
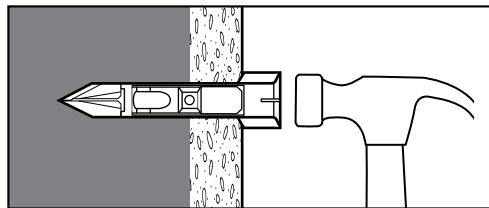
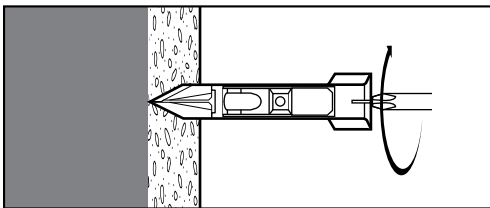

RECOMMENDED LOAD

Description	 N_{rec} [kN]	Max. h [mm]	Min. cd [mm]	Min. Spacing [mm]	Min. Edge Distance [mm]
Zip-Toggle - Nylon with Screw	0.13	12.5	40	50	50

$$\frac{N_{Rk}}{\gamma_M \cdot \gamma_F} = N_{rec}$$

$$\gamma_M = 2.1 \quad \gamma_F = 1.4$$

Recommended loads are based on the simplified design method according to ETAG 001, Annex C and are valid for one anchor. For Design loads multiply by the factor γ_F .

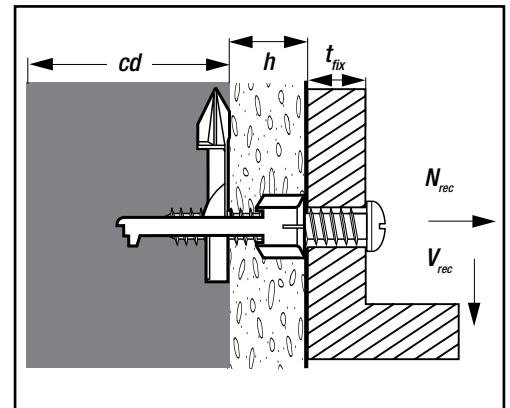

MATERIAL SPECIFICATION

Zip Toggle: Polyamide, Screw: Steel, zinc plated 5 um